

Product technical sheet

WORKOUT RB2323



14+



< 140 kg



35,4 m²

Product data

Length	369 cm
Width	243 cm
Total height	260 cm
Age group	14+ years
Maximum weight of user	140 kg
Safety zone	35,4 m ²
Free fall height	240 cm
In accordance with norm EN	16630:2015
Weight of the heaviest part	76 kg
Dimensions of the largest part	18x18x329 cm
Availability of spare parts	YES

Data is subject to change without prior notice.

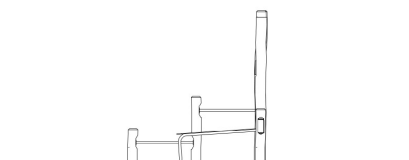
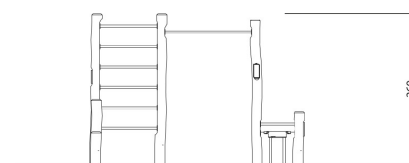
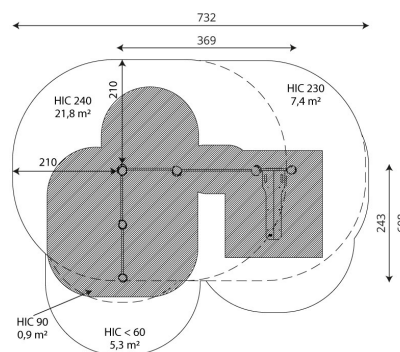
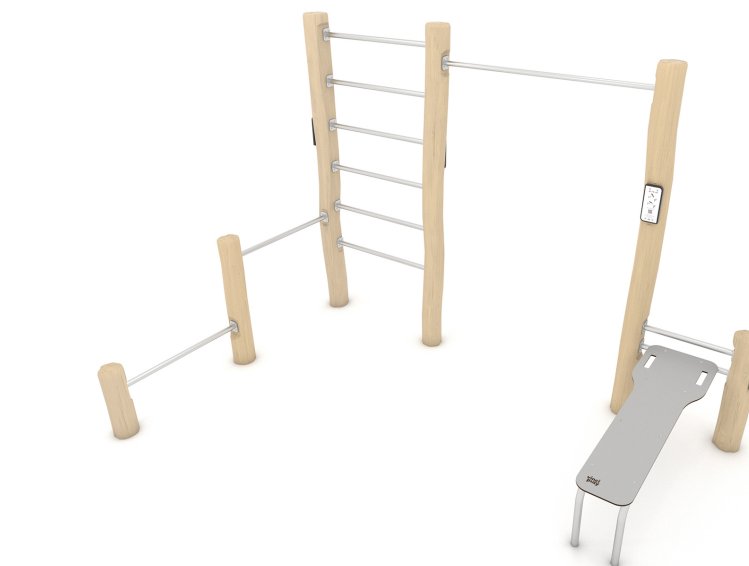

Vinci Group Sp. z o.o.
Seminaryjna 9 Street
99-400 Łowicz

VAT: 534-250-14-46
PHONE: +48 42 203 24 99 ext. 26
M: +48 793 404 991

12/04/2021

workout

biuro@vinci-play.com
info@vinci-play.com
www.vinci-play.com

1 / 3

Material specification



Construction made of Robinia - very durable acacia wood with a diameter of ~ 18 cm without sharp edges, resistant to weather conditions,



Aluminum exercise instructions plate screwed to HDPE plate, resistant to weather conditions,



Seats/backrests made of durable HPL plate, resistant to weather conditions,

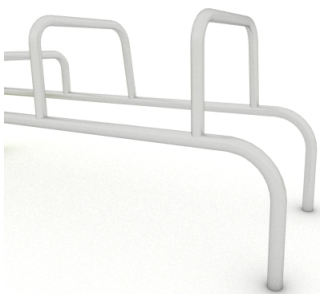

Stainless steel bars with a diameter of 38 mm for a comfortable grip during exercises.

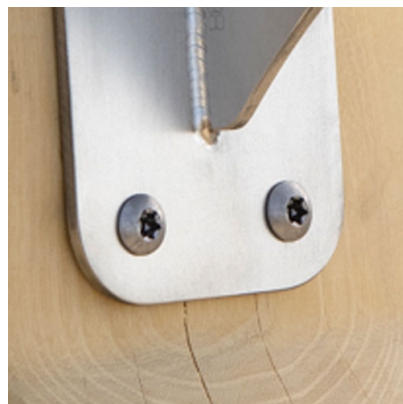

Stainless steel screws and/or screws covered with plastic caps,

Additional information

- device intended for public outdoor gyms;
- equipment has a certificate issued by an accredited entity or a declaration of conformity;
- no sharp edges or chinks that would pose a danger of jimmie the head, fingers or any other body parts;
- anchoring on flat surface, 100 cm deep;
- render is for reference only, the actual appearance of the equipment and its color may vary;

Guarantee

- 30** 30 year guarantee - Structural strength of steel and stainless steel components
- 15** 15 year guarantee - Structural failure of steel and stainless steel, for dynamic equipment
- 10** 10 year guarantee - Structural failure of high density polyethylene and high pressure laminates components
- 5** 5 year guarantee - Corrosion of stainless steel and hot dip galvanized and powder coated components; against bark beetles and rot in case of wooden structural elements

Detailed information in the guarantee card

Vinci Group Sp. z o.o.
Seminaryjna 9 Street
99-400 Łowicz

VAT: 534-250-14-46
PHONE: +48 42 203 24 99 ext. 26
M: +48 793 404 991

12/04/2021

workout

biuro@vinci-play.com
info@vinci-play.com
www.vinci-play.com

2 / 3

Amount of safe surface corresponding with free fall height:

HIC <60	9,3 m ²
HIC 90	1,0 m ²
HIC 130	2,6 m ²
HIC 240	19,7 m ²

Data is subject to change without prior notice.

Surfaces EN 16630:2015

	Description (mm)	Layer thickness (cm)	Maximum fall height (cm)
Concrete / stone / bituminous surfaces (A, B, C)	-	-	≤100
outer soil layer (A,B,C)	-	-	≤120
Turf (A,B,C)	-	-	≤150
bark (A,C)	Particle size from 20 to 80	30	≤200
		40	≤300
wood shavings/cuttings (A, C)	Particle size from 5 to 30	30	≤200
		40	≤300
sand (A,C)	Particle size from 0,2 to 2 mm	30	≤200
		40	≤300
gravel (A,C)	Particle size from 2 to 8	30	≤200
		40	≤300
attested synthetic (A, B, C)	Tested according to EN 1177		240

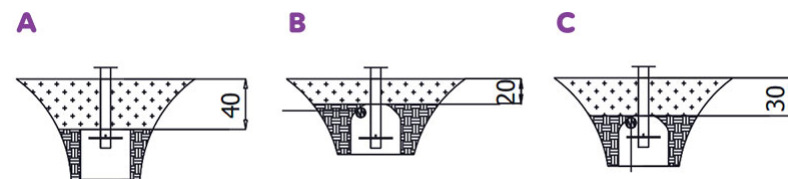

Vinci Group Sp. z o.o.
Seminaryjna 9 Street
99-400 Łowicz

VAT: 534-250-14-46
PHONE: +48 42 203 24 99 ext. 26
M: +48 793 404 991

12/04/2021

workout

biuro@vinci-play.com
info@vinci-play.com
www.vinci-play.com

3 / 3