

SZ11S-ZN/EN-A02

Guider IIs / 引领者2S

# Quick Start Guide

## ≡ 快速启动指南 ≡

中文 P11

### WARNING

1. Hot! Avoid touching the heating nozzle in operation.

2. Moving parts in printer may cause injury. Do not wear gloves or other sources of entanglement in operation.

### 注意事项

1. 高温危险！打印机喷嘴在工作时会被加热，操作时请避免接触！

2. 可动部件可能会造成卷入挤压和切割伤害。操作机器时请不要配带手套或缠绕物。

### USER GUIDE 说明书

Please refer to FlashForge official website [www.flashforge.com](http://www.flashforge.com) to download the newest User Guide and Quick Start Guide (SUPPORT-Support Center-Select a Product)

最新版本说明书请前往闪铸科技官方网站[www.sz3dp.com](http://www.sz3dp.com)下载。  
(技术支持 - 下载中心 - 说明书/快速启动指南下载)



# Kit Contents

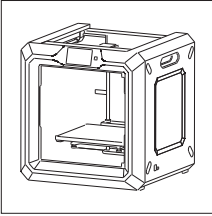

3D Printer

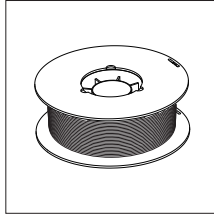

Filament Spool

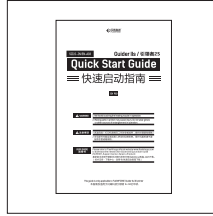

Quick Start Guide



After-sales Service Card

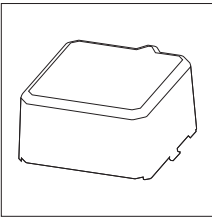

Lid

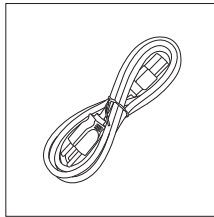

Power Cable

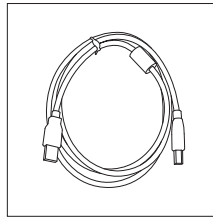

USB Cable

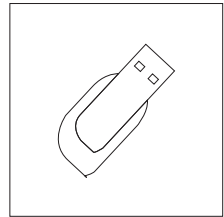

USB Stick

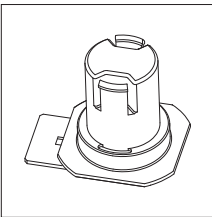

Spool Holder

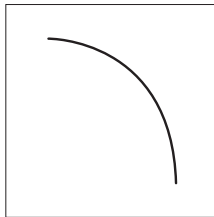

Filament Guide Tube

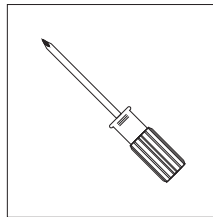

Screwdriver

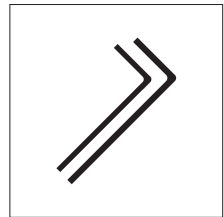

Allen Wrench

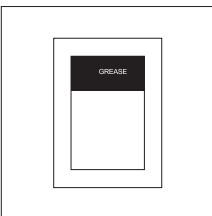

Grease

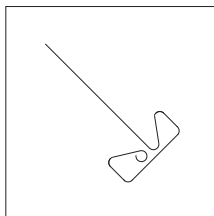

Unclogging Pin Tool

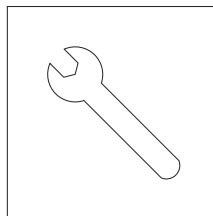

Wrench

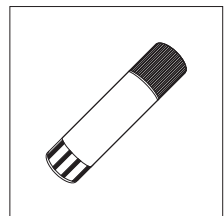

Solid Glue

## Getting to Know Your Guider IIs

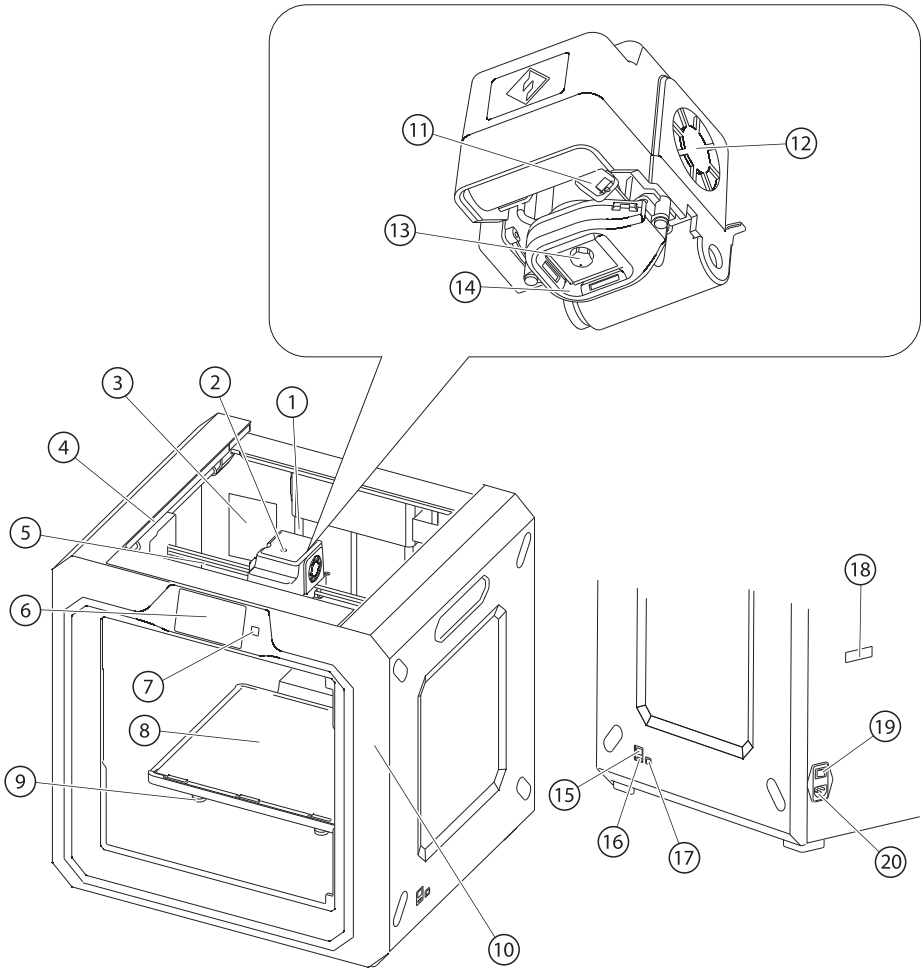

- |                     |                                    |                        |                     |
|---------------------|------------------------------------|------------------------|---------------------|
| 1. Z-Axis Guide Rod | 2. Filament Inlet                  | 3. Air-Filter          | 4. Y-Axis Guide Rod |
| 5. X-Axis Guide Rod | 6. Touch Screen                    | 7. Touch Screen Button | 8. Build Plate      |
| 9. Leveling Nut     | 10. Camera<br>(Inside the printer) | 11. Servo              | 12. Turbo Fan       |
| 13. Nozzle          | 14. Turbo Fan Baffle               | 15. Network Interface  | 16. USB Stick Input |
| 17. USB Cable Input | 18. Spool Holder Slot              | 19. Power Switch       | 20. Power Input     |



## Unpacking

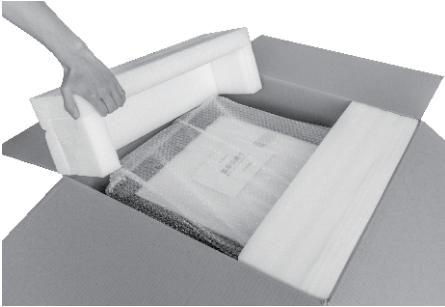

1. Open the box and remove both top foam sheets.



2. Take your Guider II's out of the box.



3. The bottom PE foam should contain: a spool of PLA filament, a spool holder, a solid glue, a USB cable, a filament guide tube and a accessories bag.



4. Remove bubble wrap.



5. Remove the top PE foam piece, which contains a power cable, a Quick start guide and a After-sales service card.

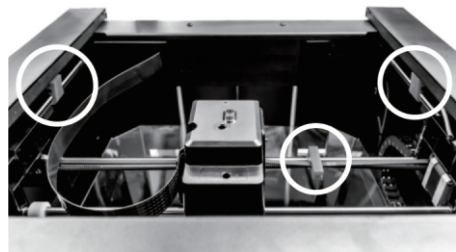

6. Remove the three buckles which are in the circled area showed in the picture.

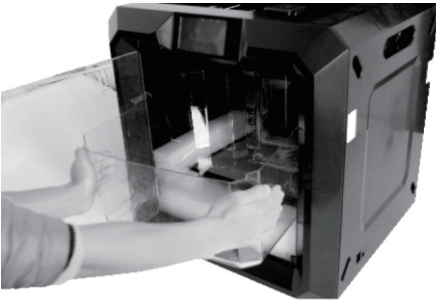

7. Tear off tape and the stretch wrap of front door. Squeeze top lid slightly from both sides to the middle so as to take top lid successfully. Remove the stretch wrap of top lid.

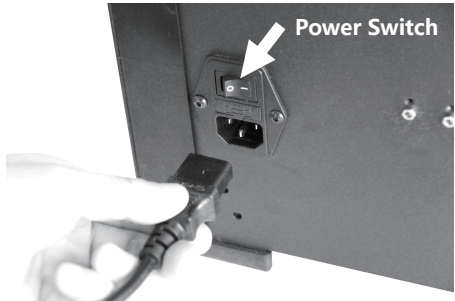

8. Take out power cable and plug the power cable into the input on the back and turn on the power switch.

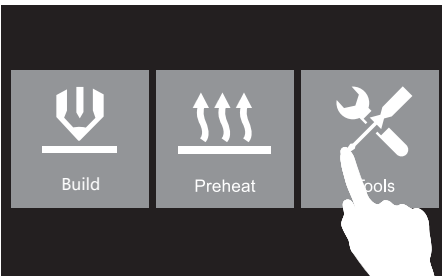

9. Tap [Tools].

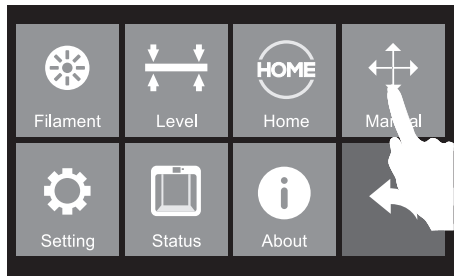

10. Tap [Manual].

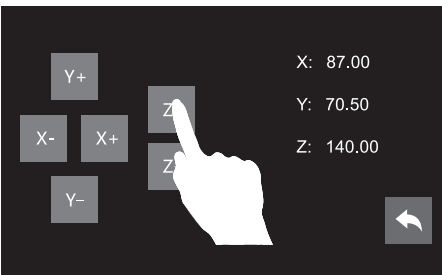

11. Tap [Z-] to partially elevate the build plate.

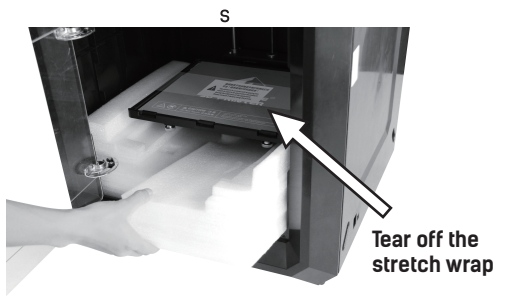

12. Remove both bottom foam pieces. Tear off the stretch wrap.

## Hardware Assembly

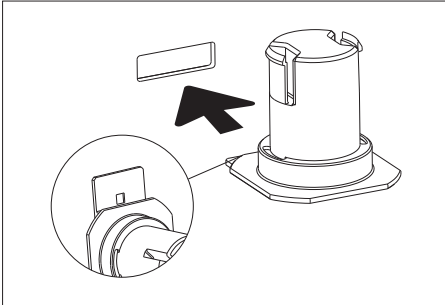

1. Locate the spool holder. Install the spool holder into the left quadrangular opening on the back.

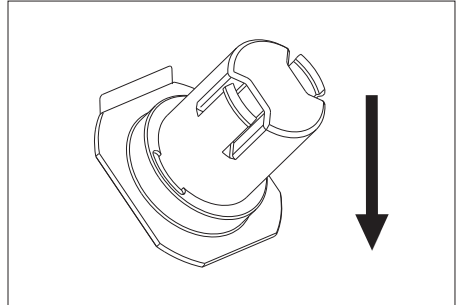

2. Turn down the spool holder to make the holder bottom cleave to the printer back.

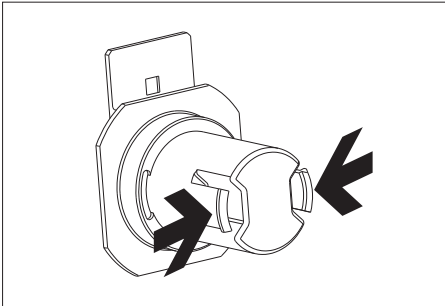

3. Squeeze the spool holder top and mount the filament spool to the holder.

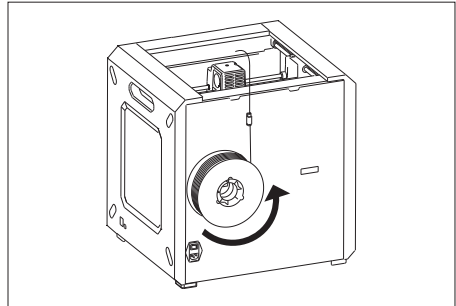

4. Secure the filament guide tube with R-shaped buckles and thread the filament through the tube. The filament spool must be oriented correctly (see above), and should feed filament from bottom to top.

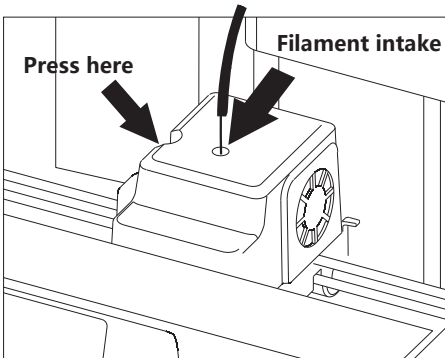

5. After filament goes through guide tube, press spring presser on the left side of extruder, and insert filament vertically into filament intake.

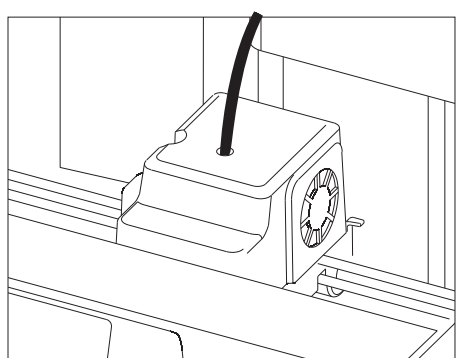

6. After inserting into filament intake, insert guide tube into extruder filament intake to fix.

## Leveling Build Plate

### How to change language

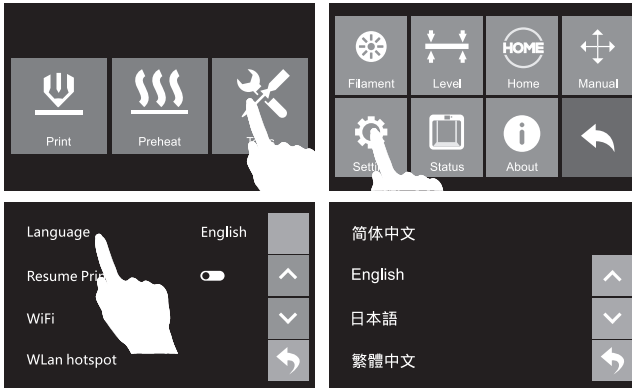

### How to use the leveling nuts

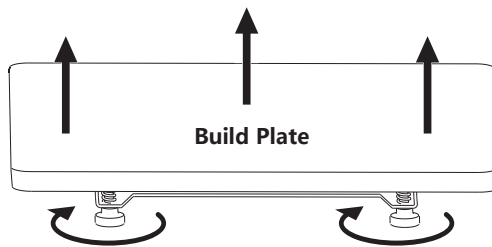

**Rotate the nut clockwise**

Raise the build plate to reduce the distance between the nozzle and build plate.

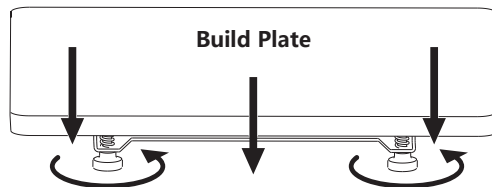

**Rotate the nut Anticlockwise**

Lower the build plate to increase the distance between the nozzle and build plate.

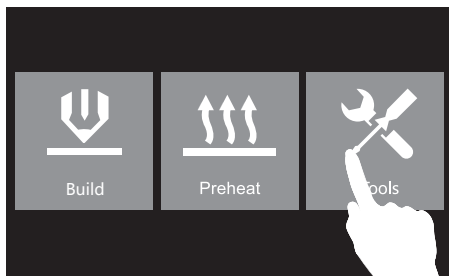

1. Tap [Tools]-[Level] on touch screen.

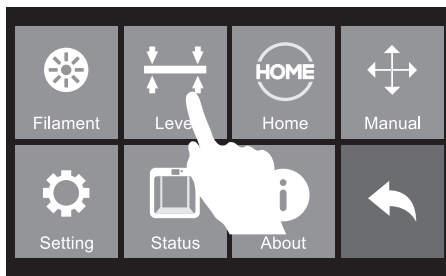

2. Tap [Tools]-[Level] on touch screen.

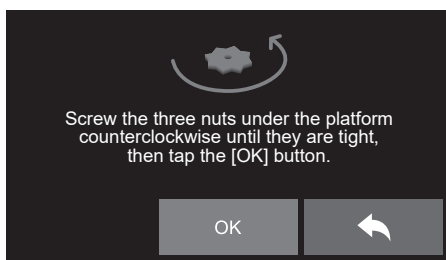
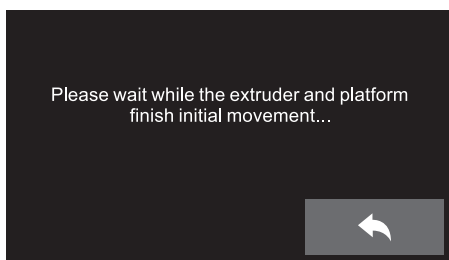

3. Please wait while the extruder and platform finish initial movements. Screw three nuts under the platform anticlockwise, then tap [OK] button.

**Attention: three nuts may be tightened up before going out, please skip this step if you find three nuts have been tightened up, and continue to following steps**

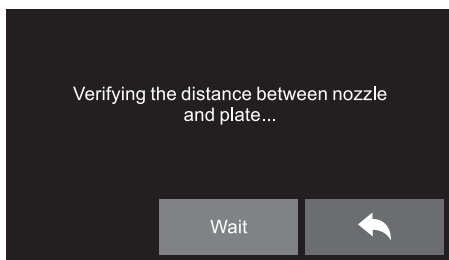

4. After tapping [OK] button, the extruder will move towards the first point and the plate will move up and down to verify the distance between nozzle and plate.

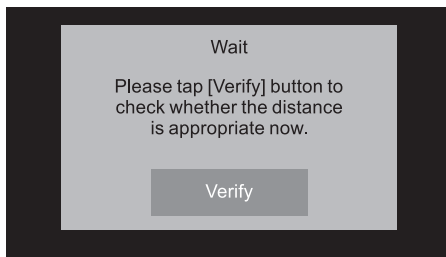
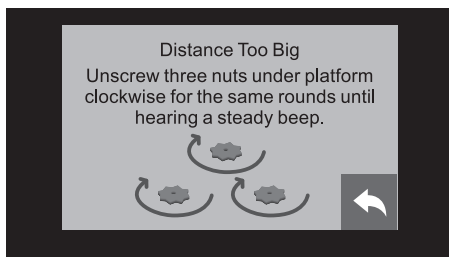

5. If the distance between the nozzle and plate is too large, rotate the three nuts underneath the platform clockwise for the same rounds until you hear a steady beep. Then tap the [Verify] button to check whether the distance is appropriate.

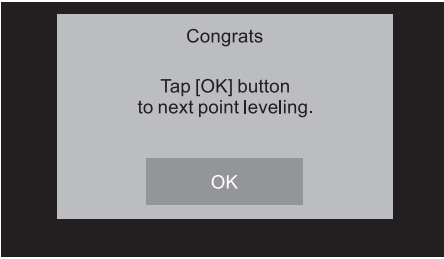

6. If the distance is appropriate, tap[ok]to next step. If the diastance still not appropriate, please follow the prompts on the touch screen to adjust till you see [ok].

**Specific operations according to prompts on the touch screen !**

## Loading Filament

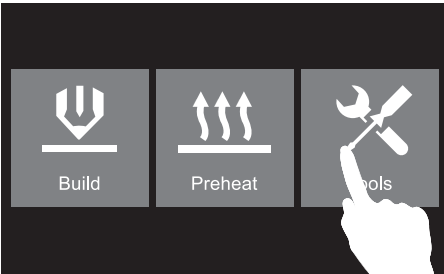

1. Tap [Tools] and then tap [Filament] and [Load] to load filament.

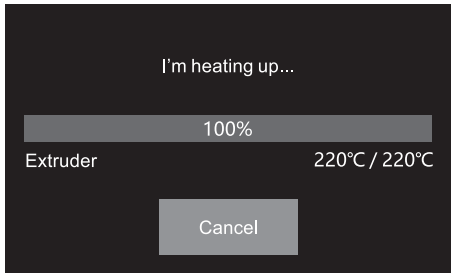
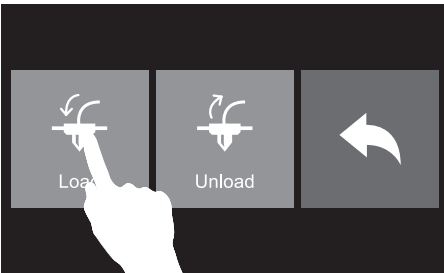

2. The extruder will automatically heat up. Once heated, filament will be drawn through the extruder. Continue extruding until the extruder provides a steady flow of filament.

# First Print

## Suggestions

1. Ensure that the build plate has been leveled before printing.
2. Ensure that the filament has been loaded in an appropriate approach.
3. Load the filament for a while to extrude all the melted filament you printed last time out of the extruder.
4. Do not leave the Guider IIs unattended during operation.

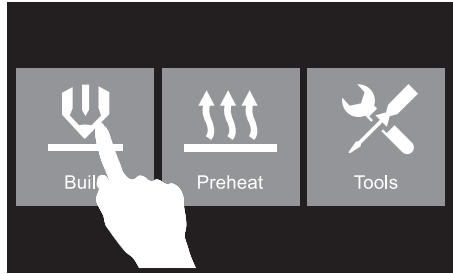

1. Please insert the USB stick into USB stick input on the right side of the printer. Tap [Build].

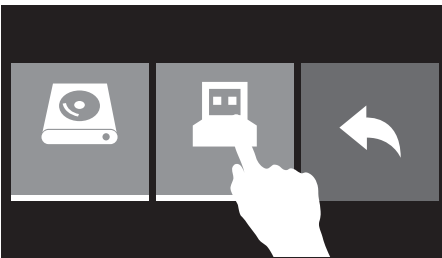

2. Tap [USB Stick].



3. Turn to next page.



4. Tap [Test Files].

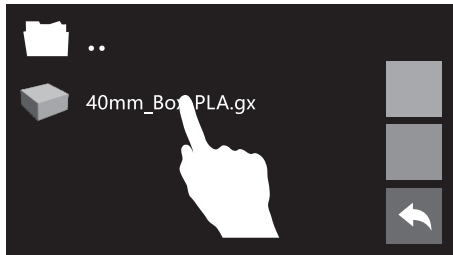

5. Tap [Test Files].

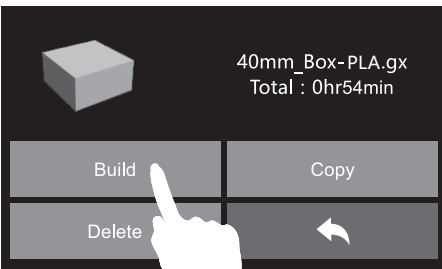

6. Tap [Build].

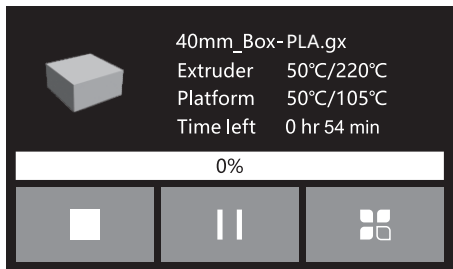

7. The printer starts to heat and it prints automatically after heating completed.

## Unloading Filament

Please follow steps below if you need to unload filament in daily use.

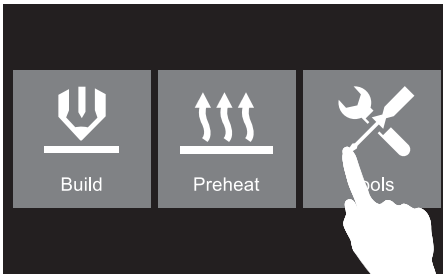

1. Tap [Tools].

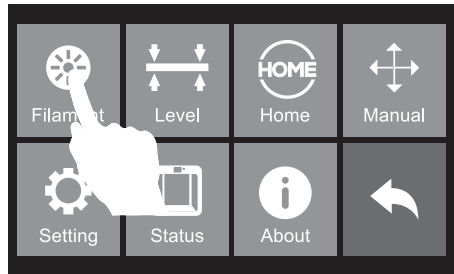

2. Tap [Filament].

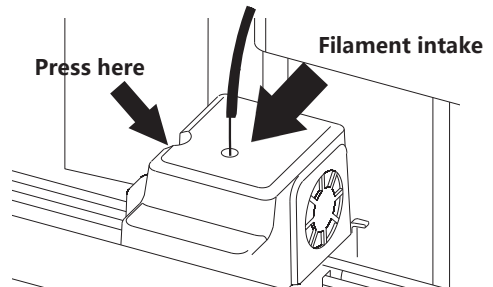
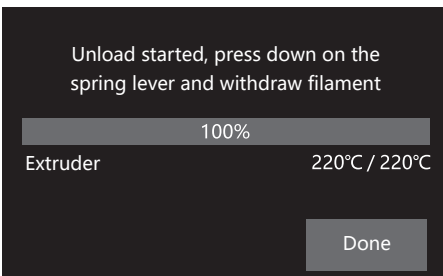
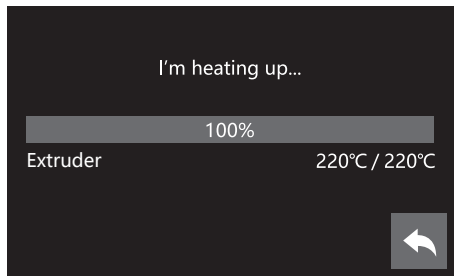
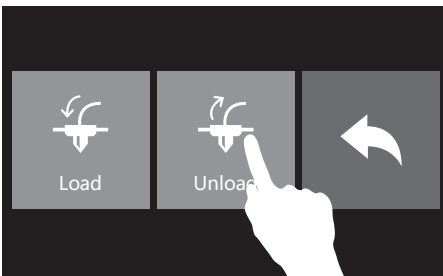

3. Tap [Unload], extruder starts to heat. When heating to target temperature, press spring presser and withdraw filament vertically after compressing filament for 3 seconds.



## 装箱物品

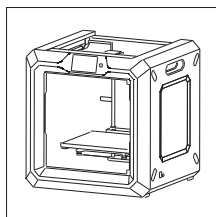

3D打印机

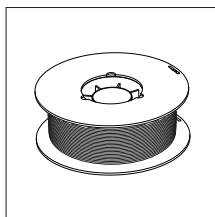

3D打印耗材

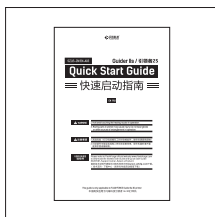

快速启动指南

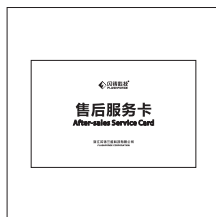

售后服务卡

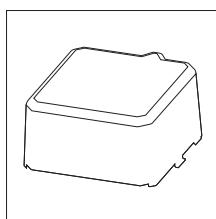

顶罩

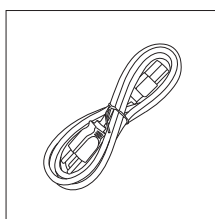

电源线

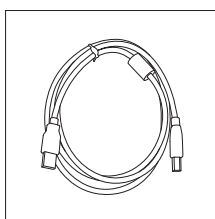

USB线

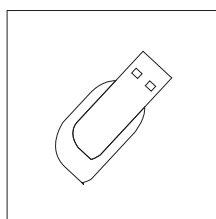

U盘

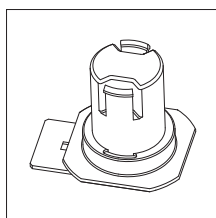

丝盘轴

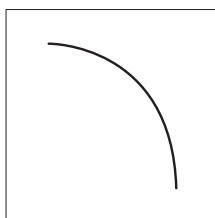

导丝管

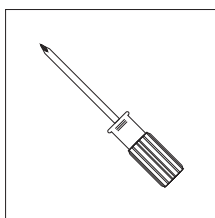

十字螺丝刀

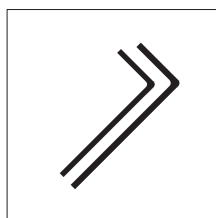

内六角扳手

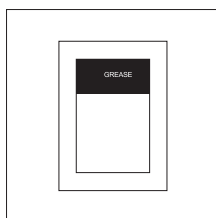

润滑脂

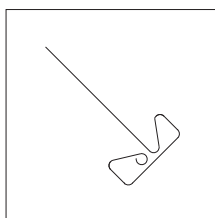

通针

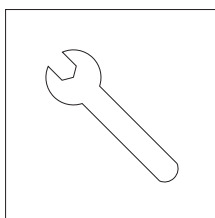

冲压扳手

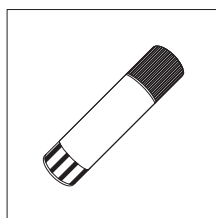

固体胶

## 部件介绍

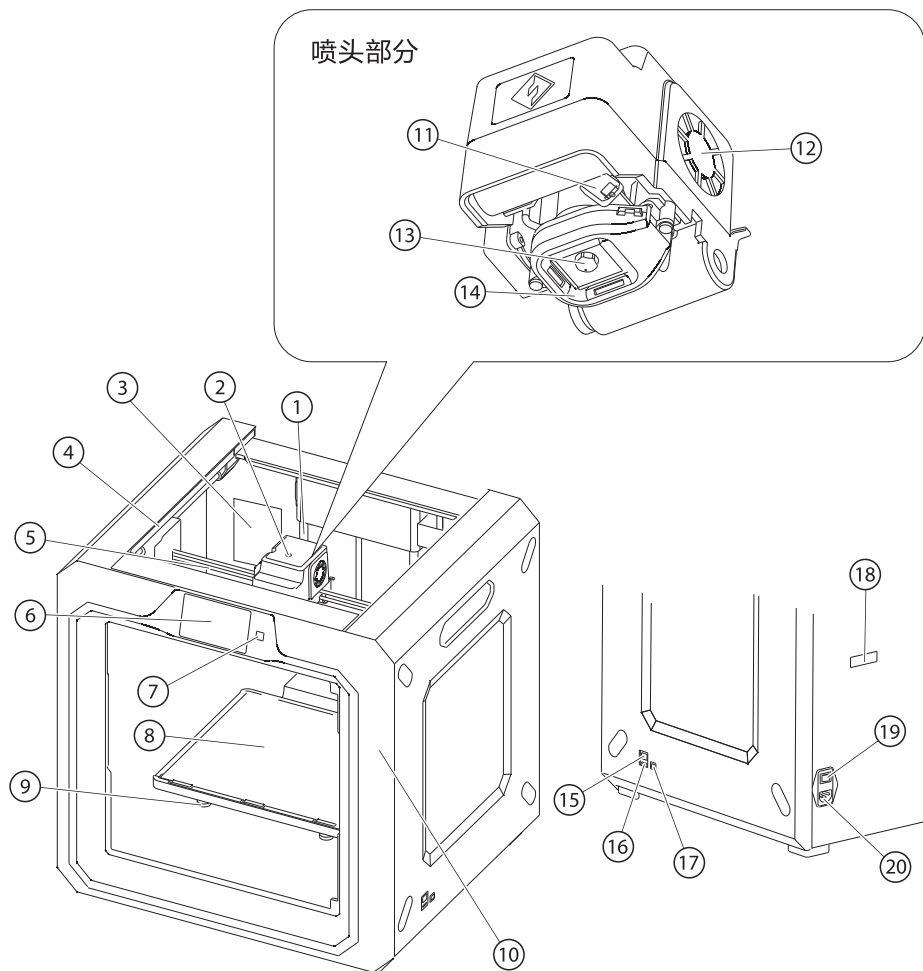

- |          |            |           |             |                |
|----------|------------|-----------|-------------|----------------|
| 1. Z轴导轨  | 2. 喷头进丝口   | 3. 过滤风扇   | 4. Y轴导轨     | 5. X轴导轨        |
| 6. 触摸屏   | 7. 触摸屏开关   | 8. 打印平台   | 9. 调平螺母     | 10. 摄像头(打印机内部) |
| 11. 调平舵机 | 12. 涡轮风扇   | 13. 喷嘴    | 14. 涡轮风扇出风口 | 15. 网线接口       |
| 16. U盘接口 | 17. USB线接口 | 18. 丝盘轴插口 | 19. 电源开关    | 20. 电源接口       |

## 开箱



1. 打开纸箱取出顶部的泡沫块。



2. 将打印机从纸箱中提出。



3. 在纸箱底部的泡沫块中包含有一卷耗材、丝盘轴、固体胶、USB线、耗材导丝管和工具包。



4. 移除气泡袋。



5. 移除打印机顶部泡沫块，上面附带有电源线、《快速启动指南》和《售后服务卡》。撕除固定前门的无痕胶带。

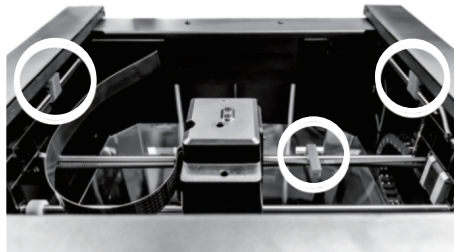

6. 移除图中圆圈标记处的三个卡扣。



7. 撕保护前门的无痕胶带和缠绕膜。轻轻从两侧向中间挤压顶罩，以便顺利取出顶罩。撕除包裹顶罩的缠绕膜。

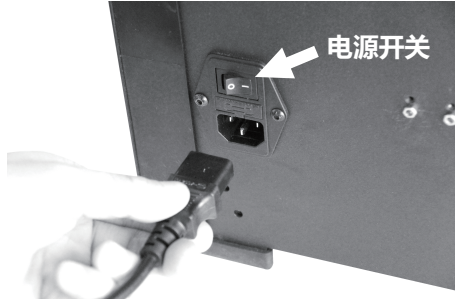

8. 取出电源线，插入打印机背部的电源接口，按下图中箭头所示的电源开关，接通电源。

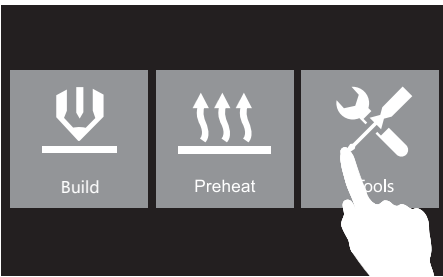

9. 开机后在液晶屏上点击[Tools]。

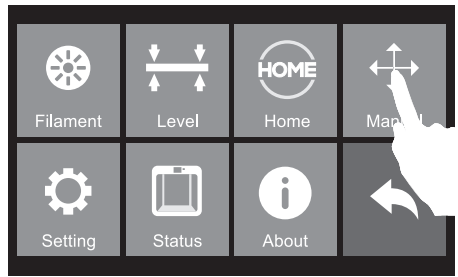

10. 点击[Manual]。

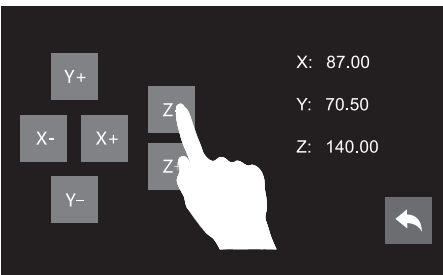

11. 按住“Z-”将打印平台上升至机身中部。

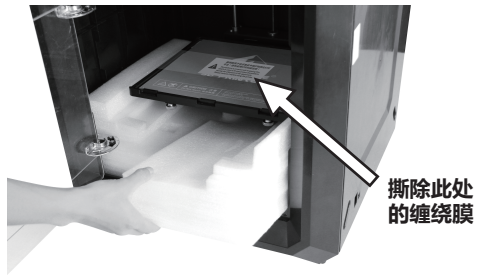

12. 取出下方的两块泡沫块，撕除固定打印平台的缠绕膜。

## 硬件安装

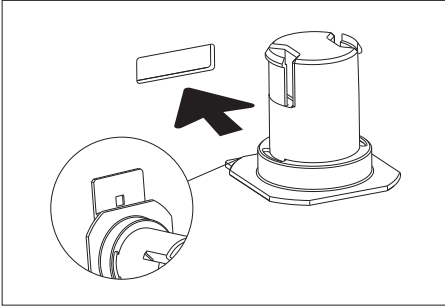

1. 在水平姿态下，将丝盘轴底部有突起的一端插入打印机背部的丝盘轴插口中。

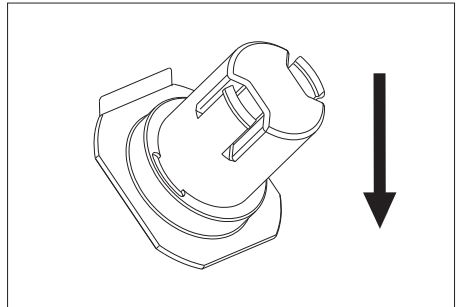

2. 丝盘轴插入丝盘轴插口后，让丝盘轴底部向下贴住打印机背部。

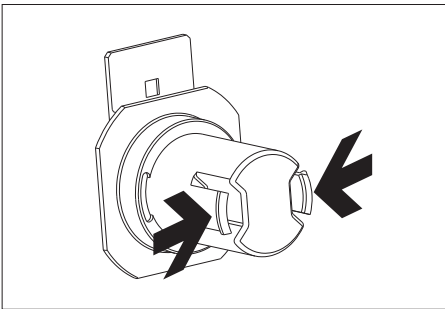

3. 轻轻挤压丝盘轴顶部的压片，然后将丝盘轴插入丝盘轴中。

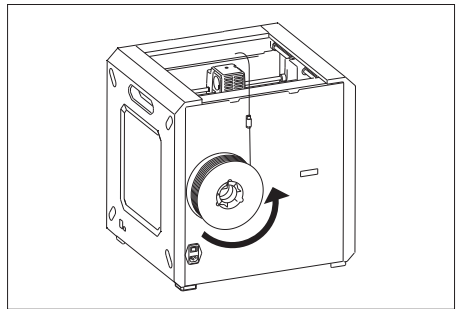

4. 将导丝管安装在位于打印机背部的线扣中，然后将耗材从导丝管中穿过。请确保耗材从丝盘下方进入导丝管。（图中箭头方向）

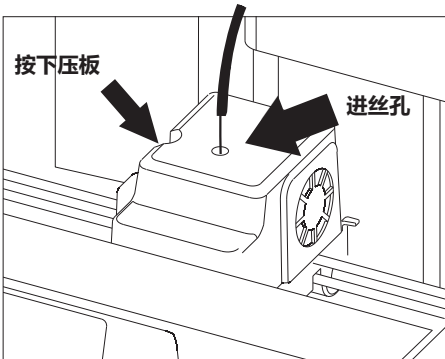

5. 耗材穿过导丝管后，按下喷头左侧的压板，然后将耗材垂直插入喷头进丝孔中。

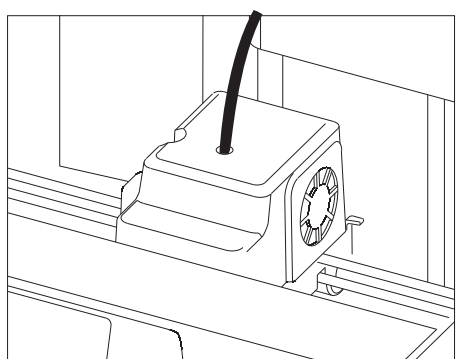

6. 耗材插入进丝孔后，再将导丝管插入喷头进丝孔固定。

## 调平

### 将液晶屏语言设置为中文

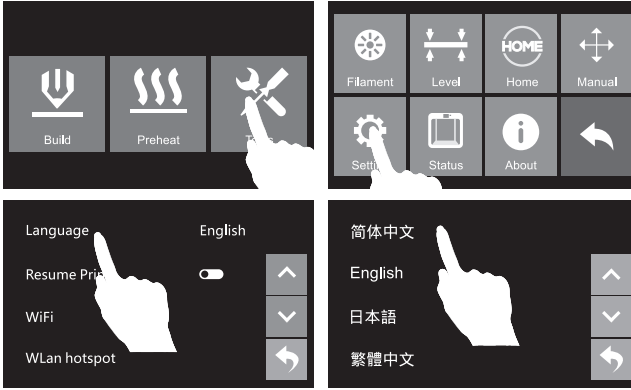

1. 插上电源线，打开电源开关开机。引领者IIs 在出厂时默认操作语言为英文，请根据上图步骤切换至中文：在触摸屏上依次点击 [Tools]、[Setting]、[Language]、[简体中文]。
2. 语言设置完成后，点击返回键返回上一界面，准备开始调平。在开始调平之前，让我们先了解一下调平螺母的作用。

### 如何通过调平螺母调节打印平台

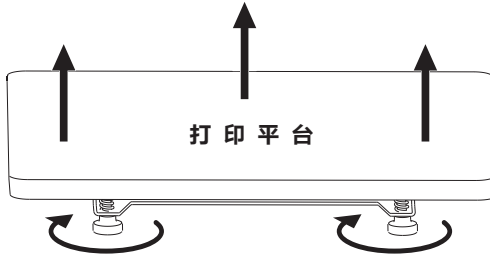

#### 顺时针旋转螺母

打印平台上升，喷嘴与平台之间间距变小

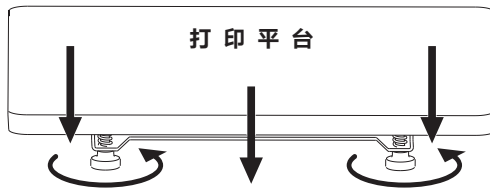

#### 逆时针旋转螺母

打印平台下降，喷嘴与平台之间间距变大



1. 在触摸屏上点击[工具]。

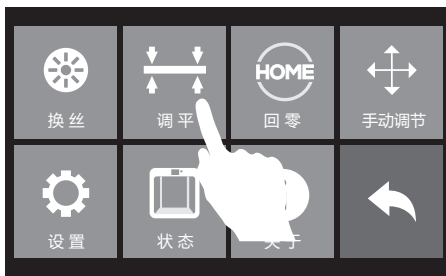

2. 点击[调平]。

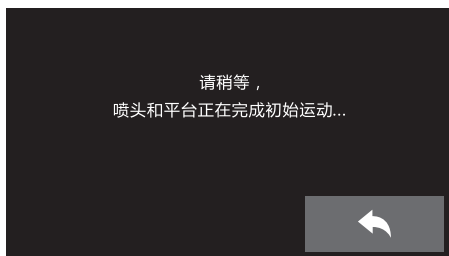

3. 待初始化运动完成后逆时针拧紧底板下的三颗螺母，点击[确认]。

**请注意：在出厂前的测试中，三颗螺母可能已经被拧紧，如发现螺母已处于拧紧状态，请跳过拧紧螺母这一步骤，继续进行后续操作。**

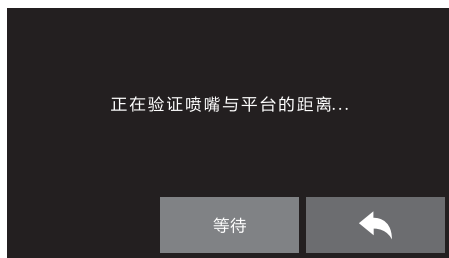

4. 点击【确认】后，喷头开始移向第一个点，打印平台会验证喷嘴与平台之间的距离。

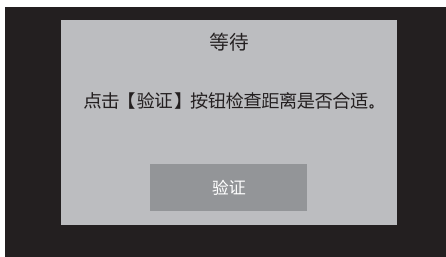

5. 根据触摸屏提示，顺时针调节平台下的三颗螺母一致的圈数，直到听到持续稳定的提示声，之后点击[验证]进行确认。



6. 若距离合适，点击[确认]进行下一步骤。若距离依然不合适，请继续接触摸屏提示操作，直至调平全部完成。

**具体操作请严格按照触摸屏上的提示进行！**

## 填装耗材



1. 在触摸屏上点击[工具]。



2. 点击[换丝]。



3. 点击[进丝]后，喷头开始加热。当喷头加热到预定的温度后会自动开始进丝。看到喷嘴开始出丝时请勿立即停止进丝，直到耗材均匀出丝为止。

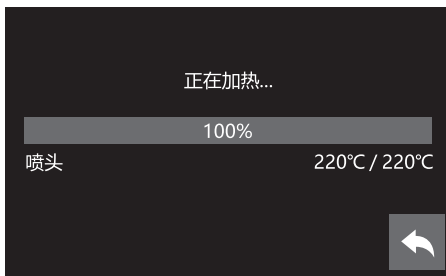



# 首次打印

## 打印建议

1. 在打印开始前请确保打印机已经过调平；
2. 在打印开始前确保耗材安装正确，没有打结或卡住；
3. 喷头内可能残留有少量耗材，请进丝一段时间，确保上一次打印的耗材已经全部挤出；
4. 不可以长时间无人看守的情况下使用3D打印机



1. 将随机附带的U盘插入打印机右侧的U盘接口。在触摸屏上点击[打印]。

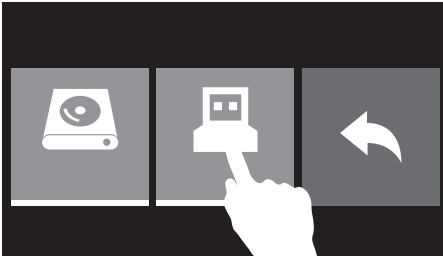

2. 点击[U盘]。



3. 点击[翻页]。



4. 点击[Test Files测试模型]文件夹。

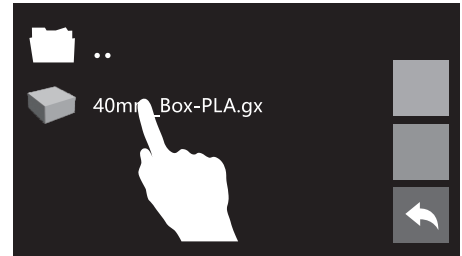

5. 点击测试模型进行打印测试。

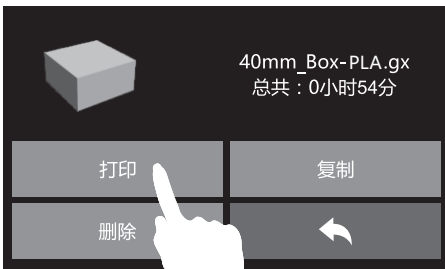

6. 点击[打印]。

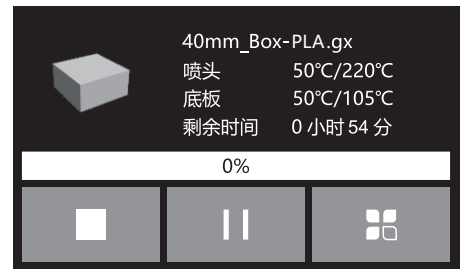

7. 打印机开始加热，加热完成后自动开始打印。

## 退丝操作

在日常使用中,如果需要更换耗材,请按下列步骤操作。



1. 在触摸屏上点击[工具]。



2. 点击[换丝]。

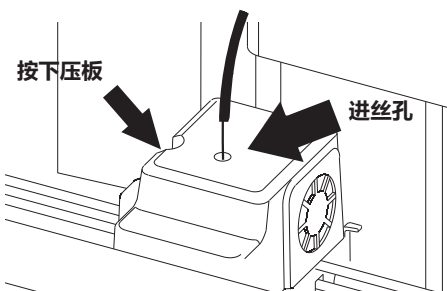
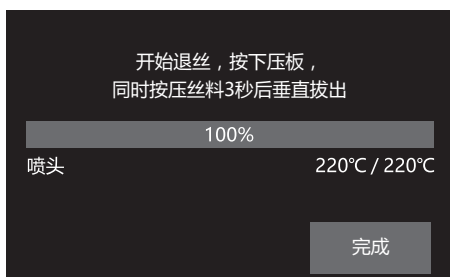
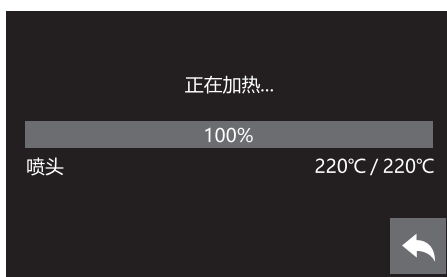

3. 点击退丝, 喷头开始加热。当喷头加热到预定温度后, 按下喷头侧边的压板, 同时向下按压耗材3秒后垂直拔出。





YouTube



优酷自频道

Scan QR to Get More  
After-Sales Support  
扫描二维码获得更多售后支持



---

After-Sales Service: [support@ff3dp.com](mailto:support@ff3dp.com)

售后专线 : [support@ff3dp.com](mailto:support@ff3dp.com)

---

Amazon.com orders only: [597891915@qq.com](mailto:597891915@qq.com)

美国亚马逊专线 : [597891915@qq.com](mailto:597891915@qq.com)

---

电话 : 400 6991063 官方网站 : [www.sz3dp.com](http://www.sz3dp.com) 地址 : 浙江省金华市仙源路518号

Tel: +86 579 82273989 Web: [www.flashforge.com](http://www.flashforge.com) Add: 2/F, No.518, Xianyuan Road, Jinhua, Zhejiang, China