

0400

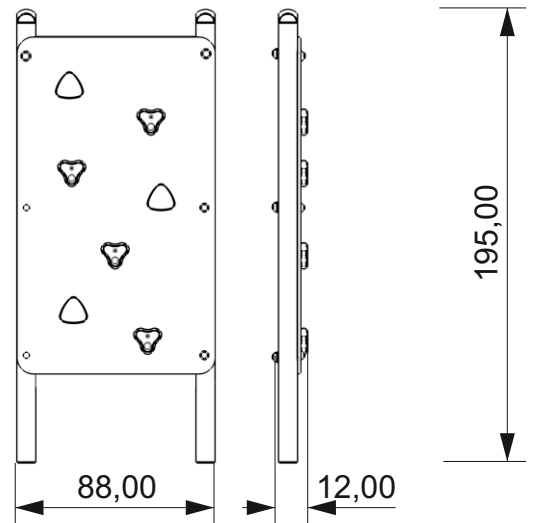

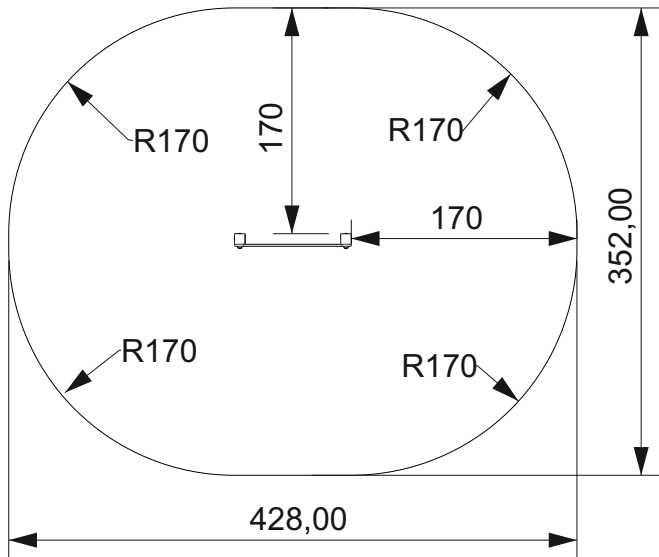

80,00

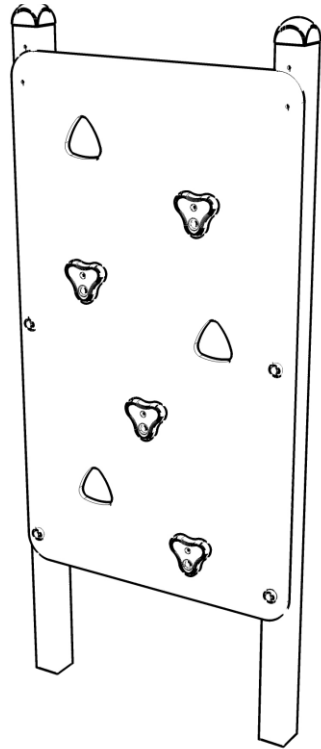
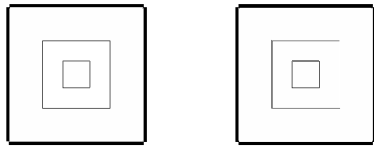
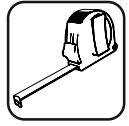
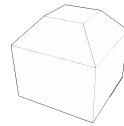

2x

0,06 m³



48h

A.

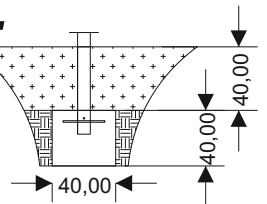

B.

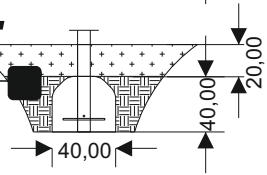

C.

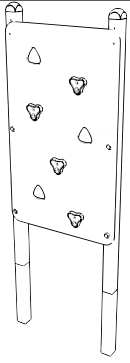
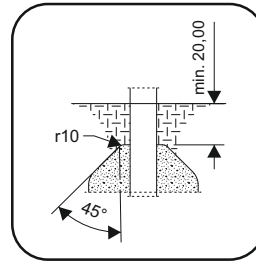
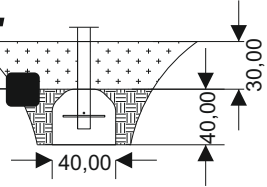

1x

1

