

€ GF

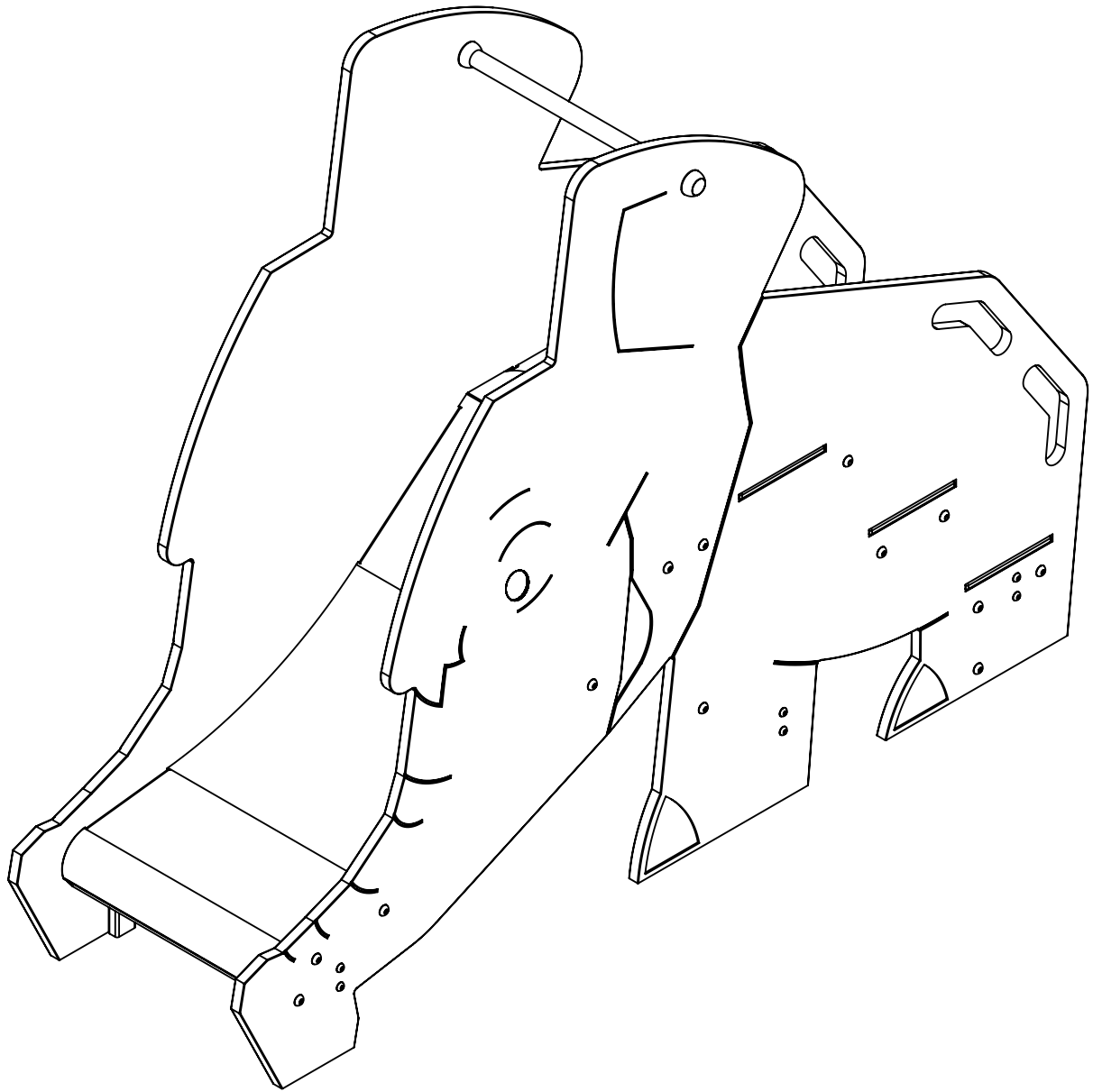

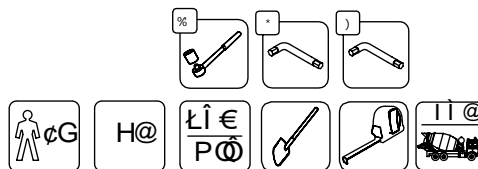



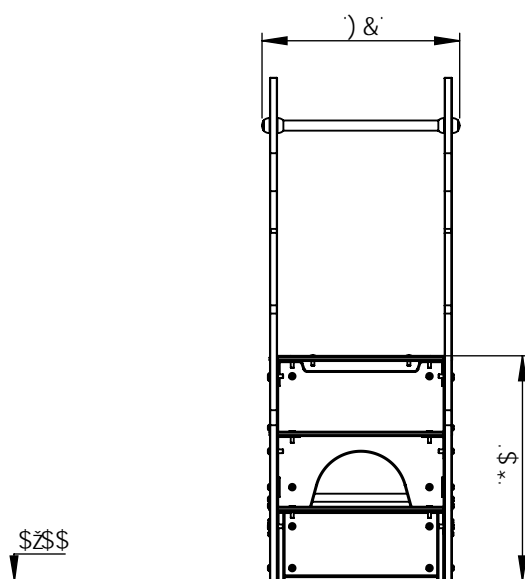
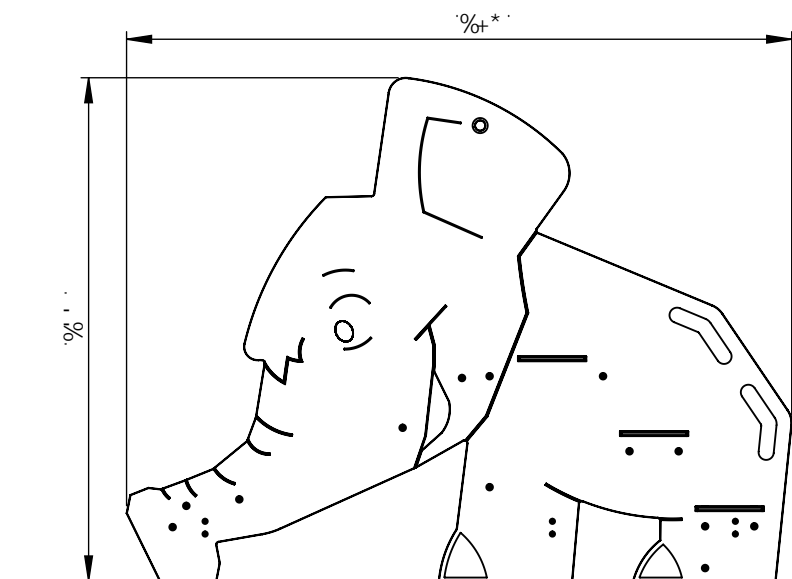
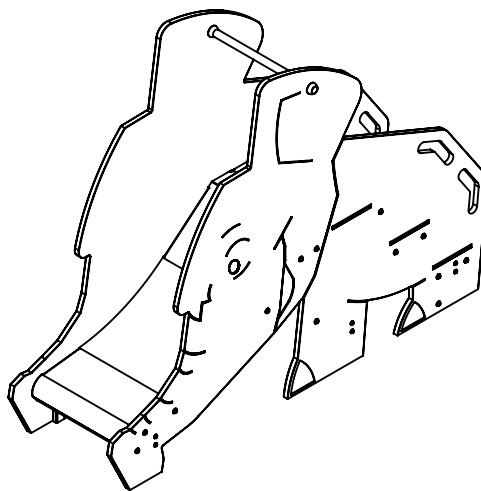
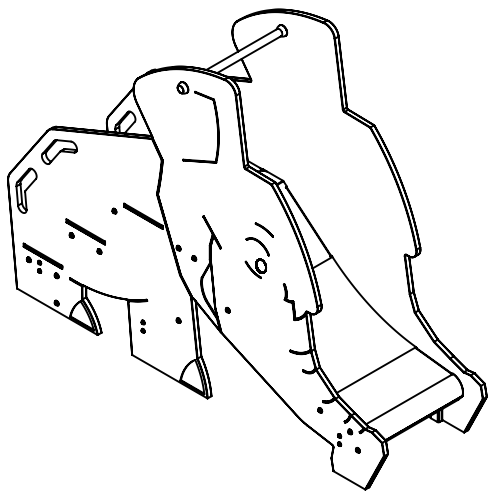
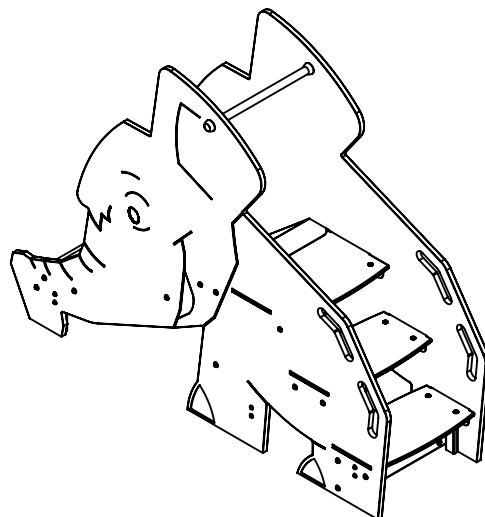
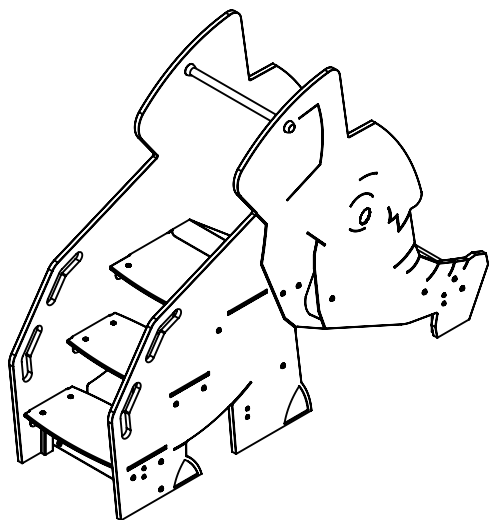

0/1 Q
j \$%&
\$*"%&&\$%
5"<"

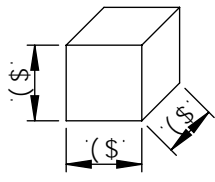
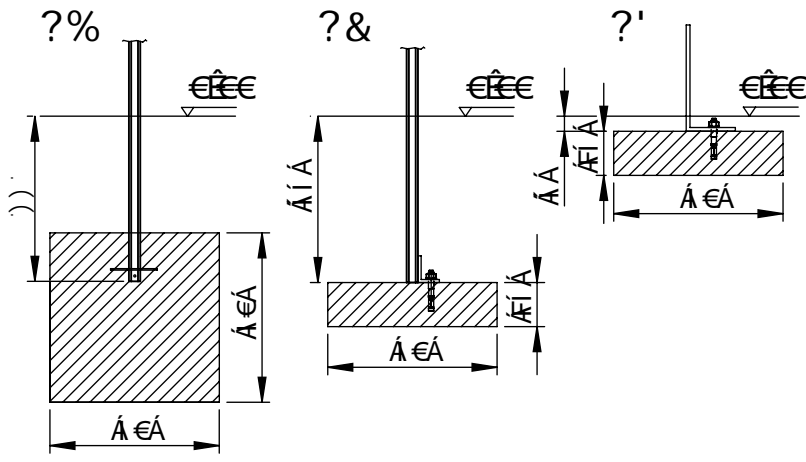

play
vinci





 T ì ç F G € ç î	SG 	 T F € ç F G € ç î	SH 
BCH B7 @ 898 		BCH B7 @ 898 	

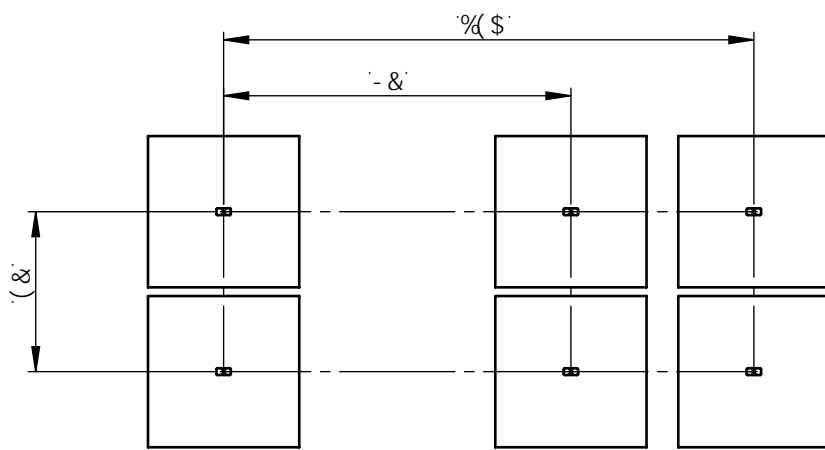
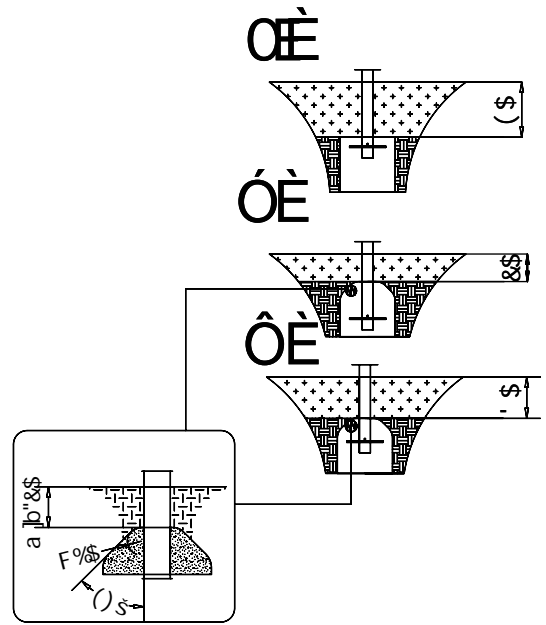

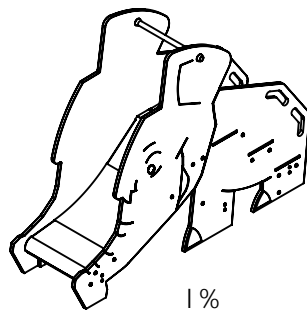
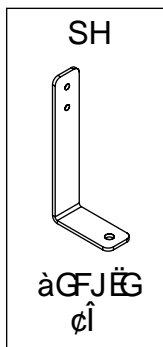
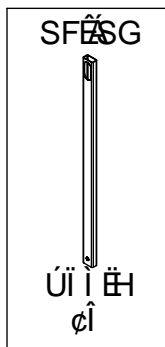
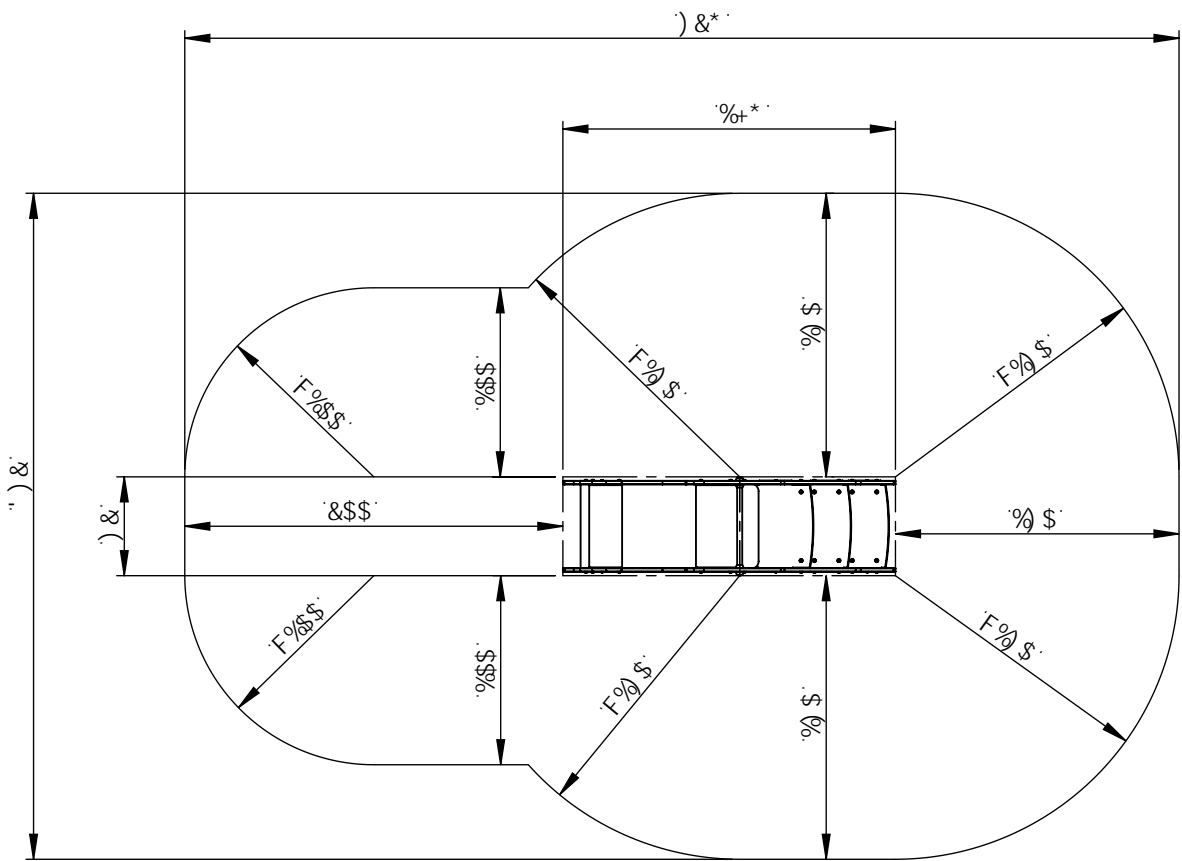

5z	G57 ^{1/2} M4+
5z	G56 ^{1/2} M5.M5+
3z	X223



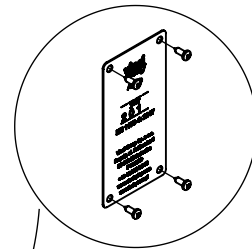
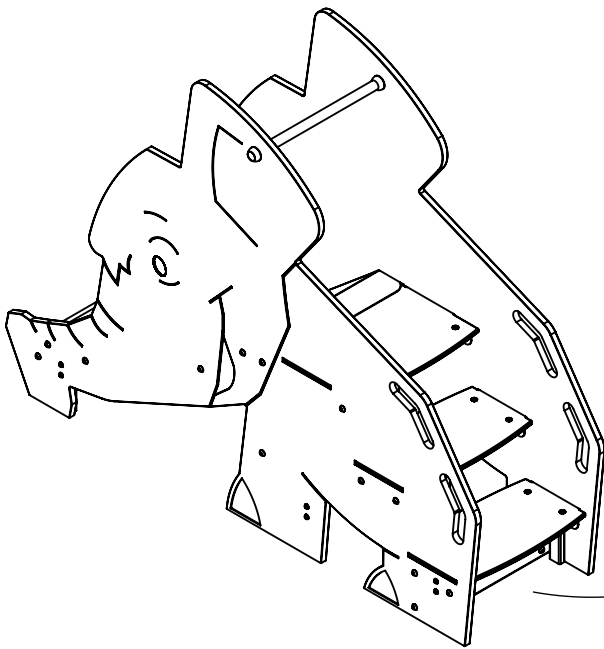

X€€F

